

W4 30, 40, 45, 50

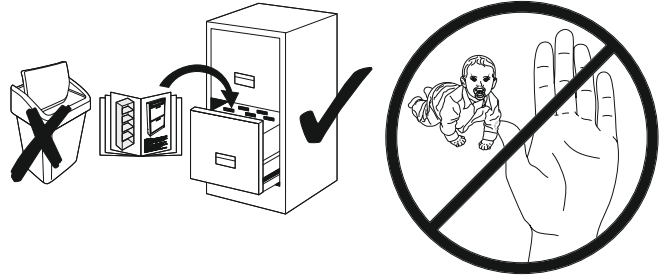

a1 8x35 x....(x8)	bc0 x....(x3)	bc1 x....(x3)	c1 Euro 4x13 x....(x6)	d2 x....(x12)	e0 x....(x8)	e1 x....(x8)	f1 x....(x8)	k3 4x22 x....(x2)
h1 x....(x1)	m x....(x1)	n1 3x16 x....(x10)	n2 3,5x16 x....(x4)	p01 x....(x6)	p02 COLOUR x....(x6)	p9a x....(x1)	r4 x....(x8)	w16 x....(x1)

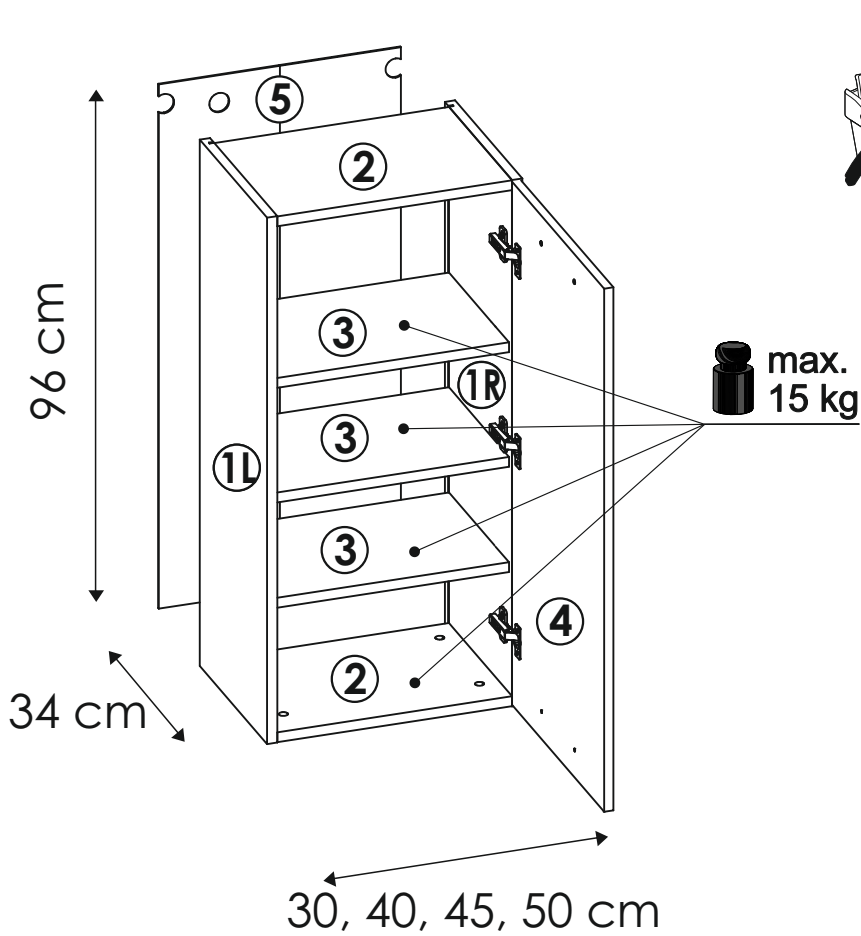
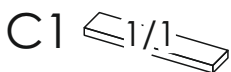

- 1L -C1
- 1R -C1
- 2 -C1
- 3 -C1
- 4 -C1
- 5 -C1

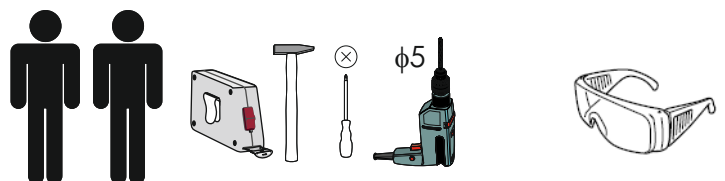

1

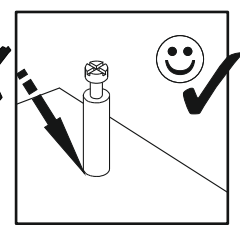
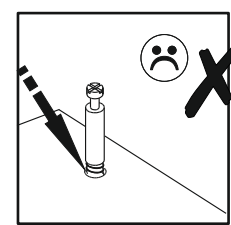
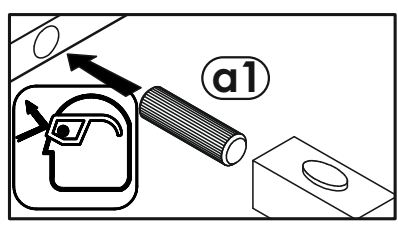
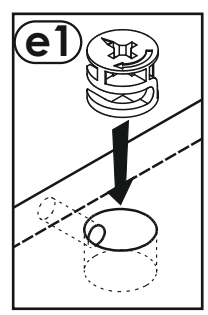
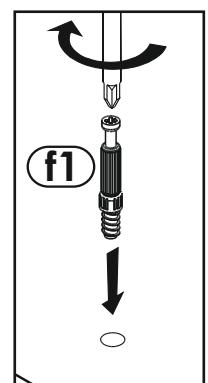
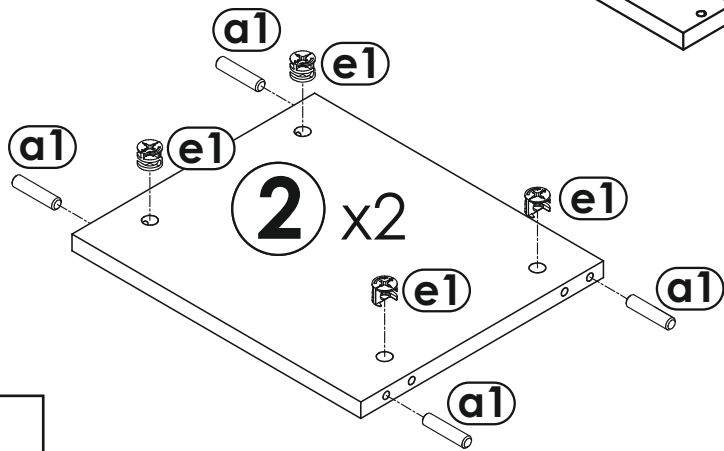
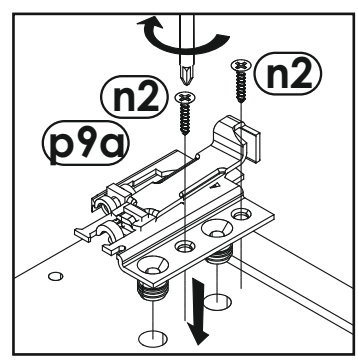
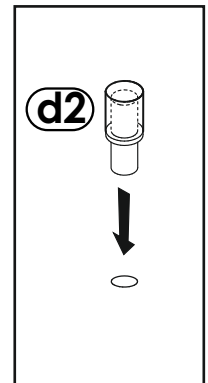
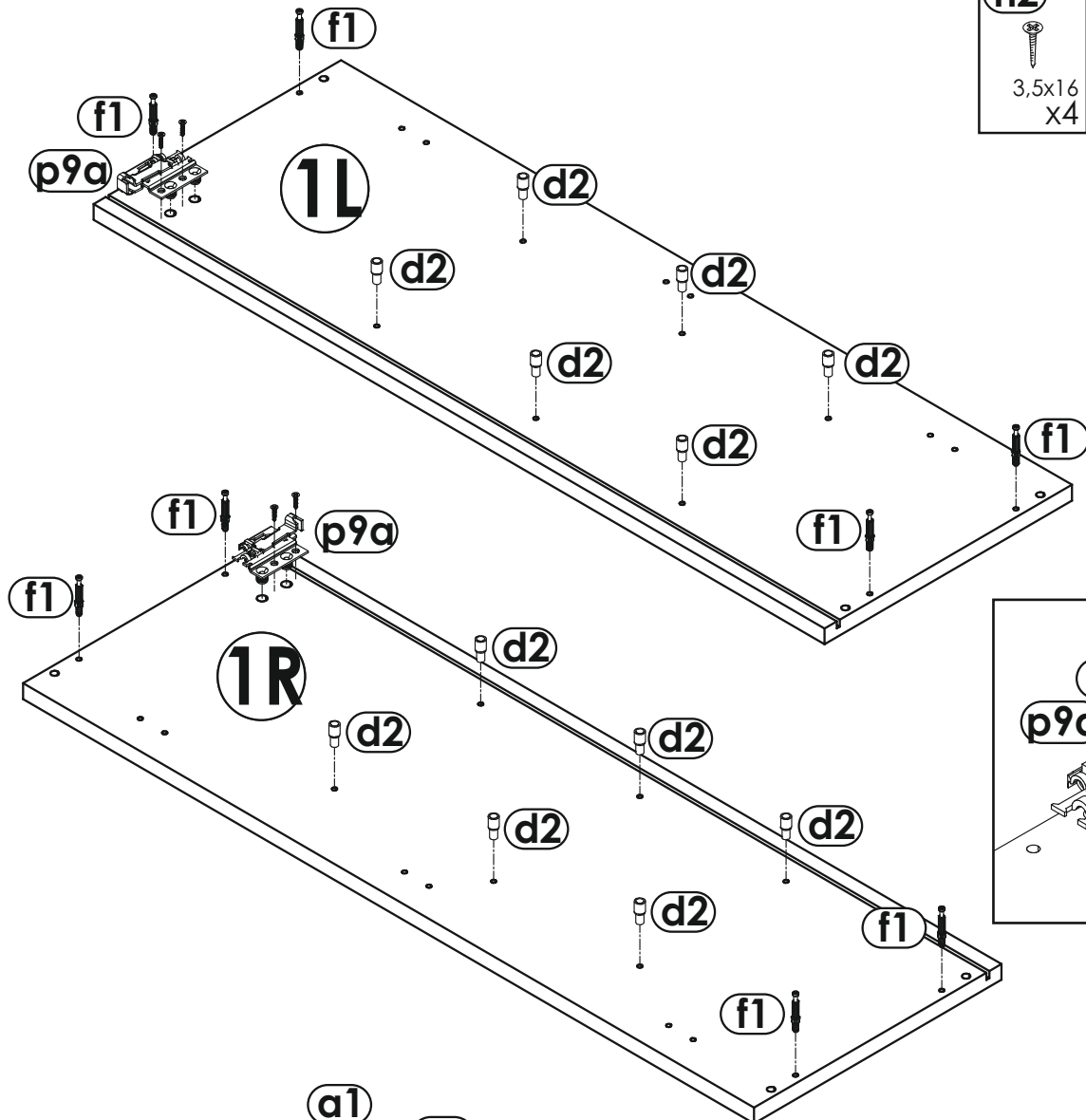
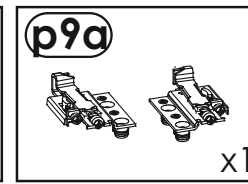
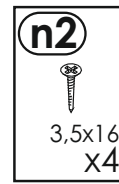
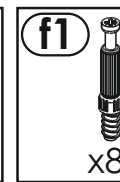
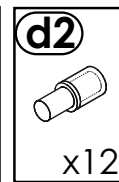
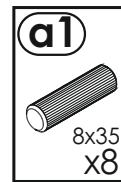
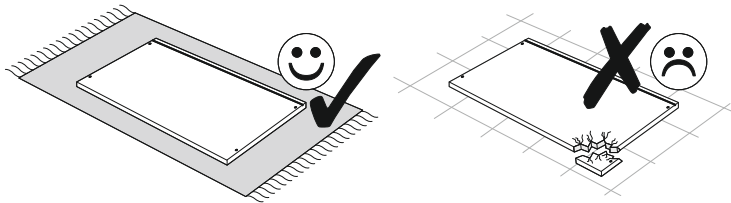

2

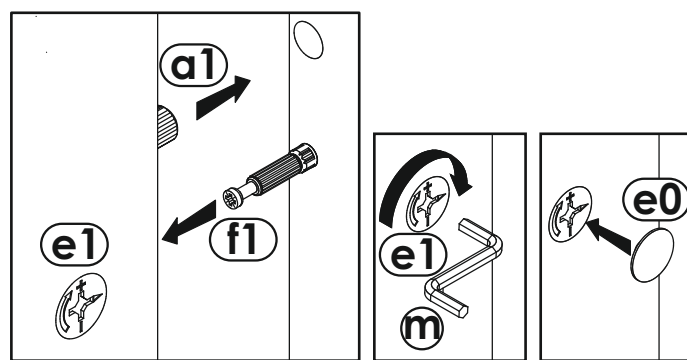
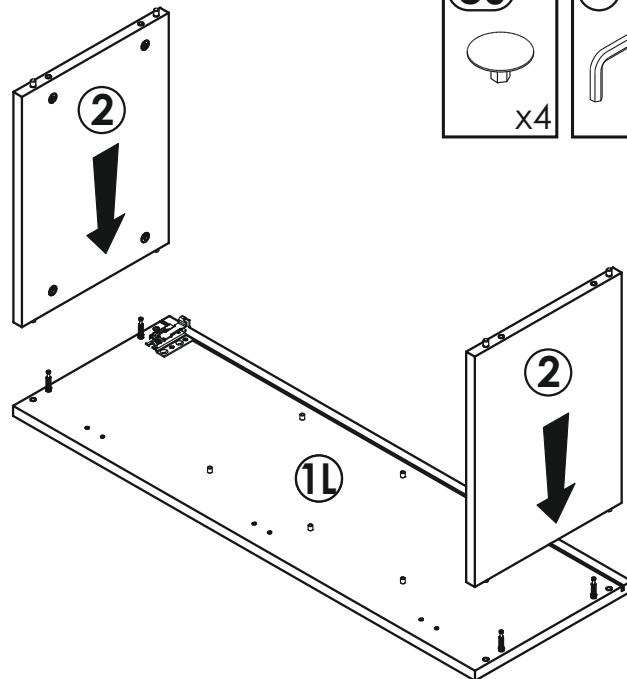
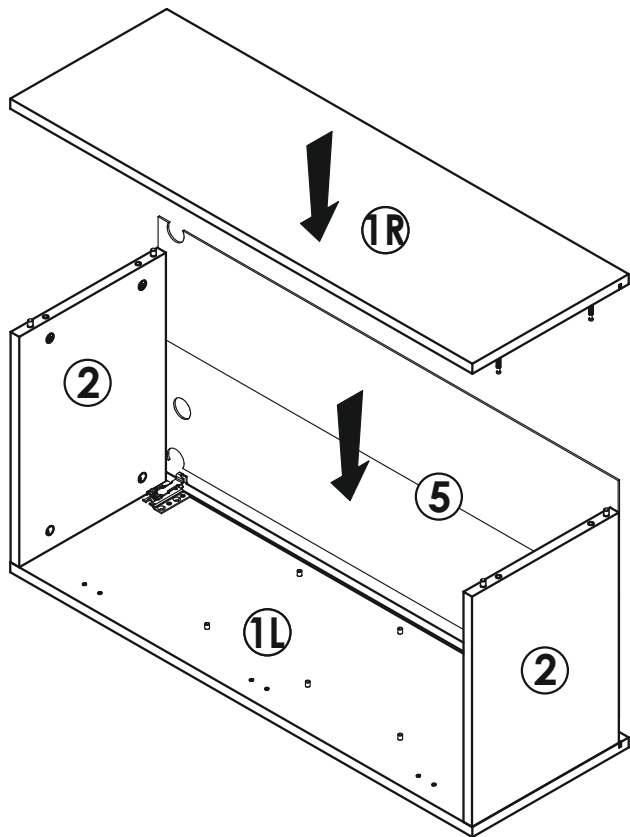
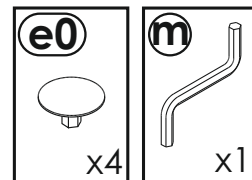
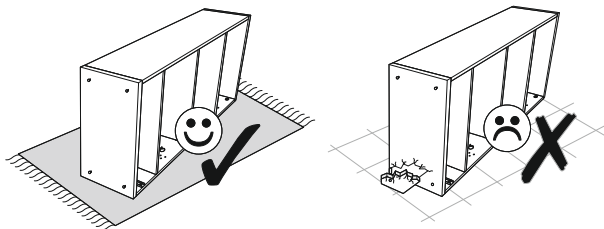

3

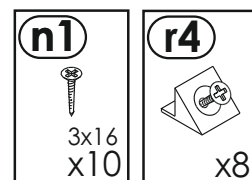
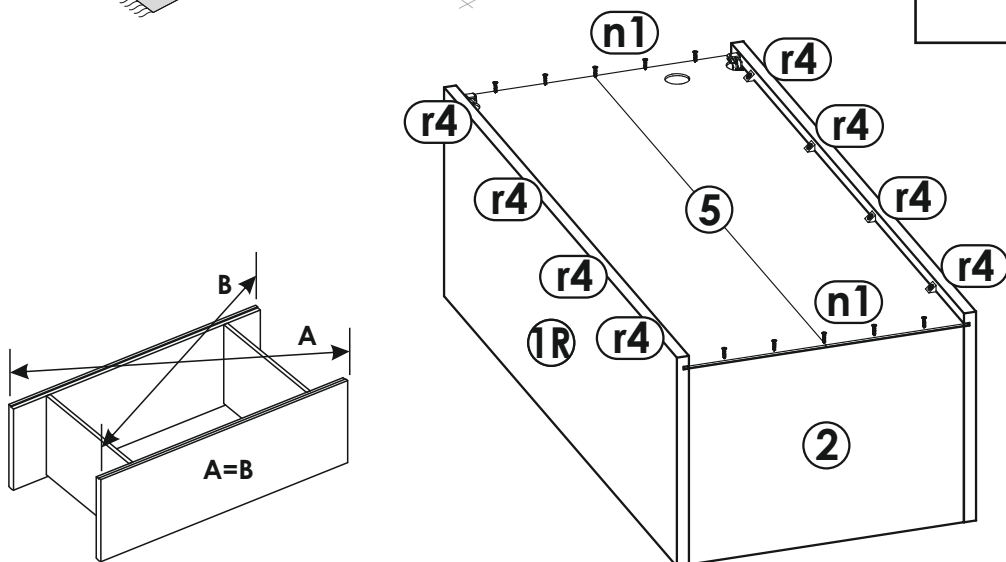
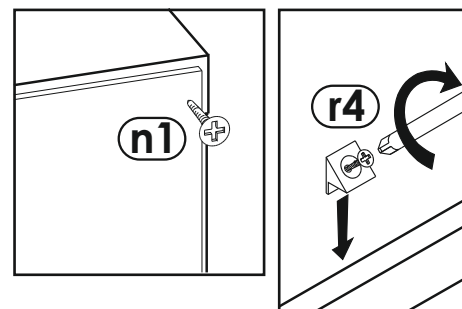
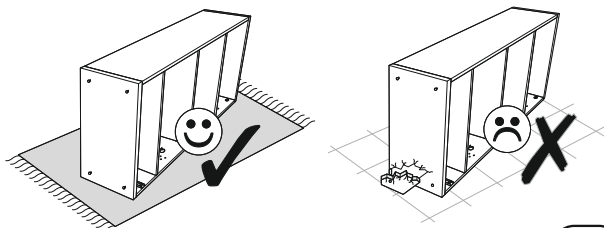

4
▼

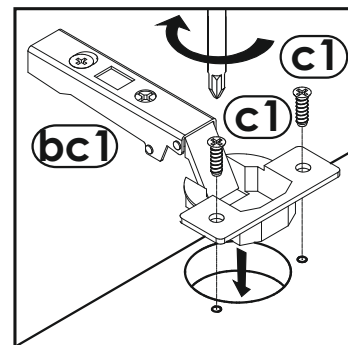
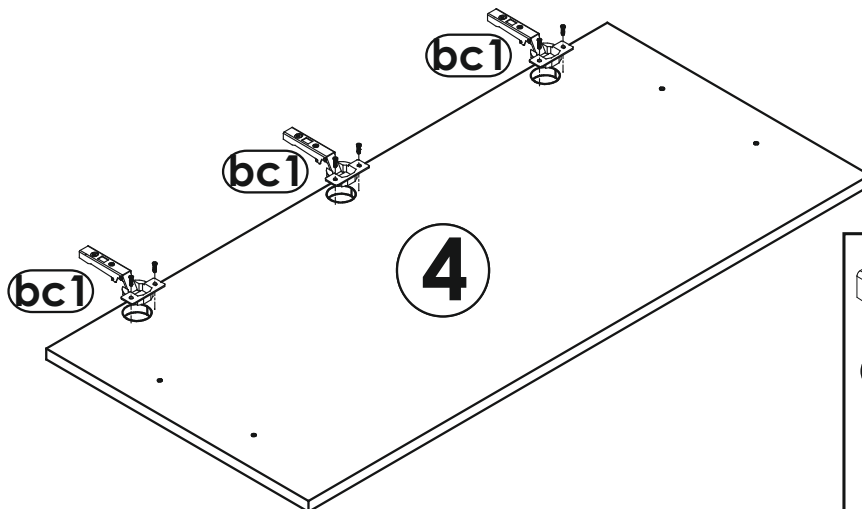
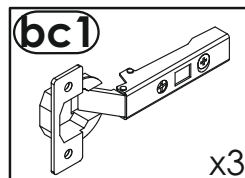
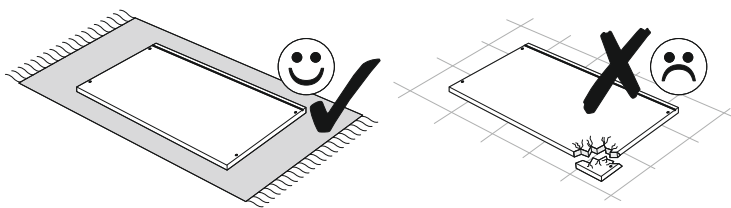

5
▼

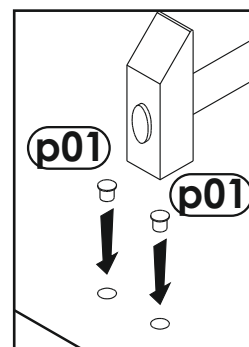
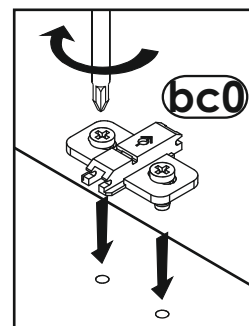
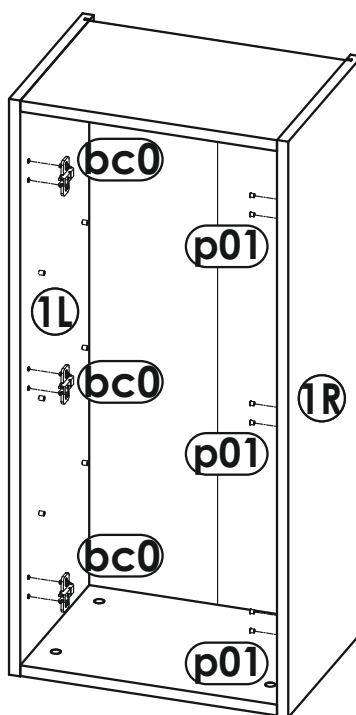
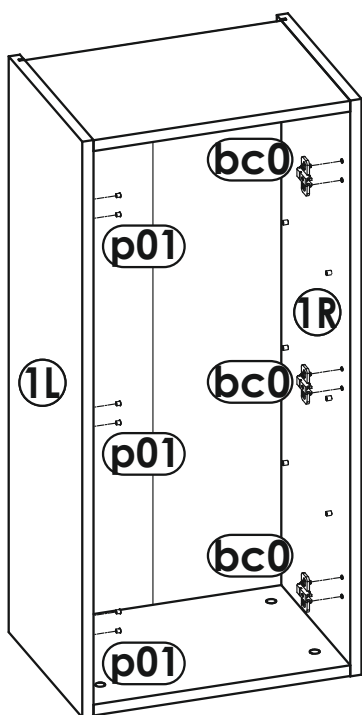
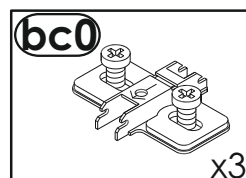
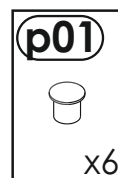
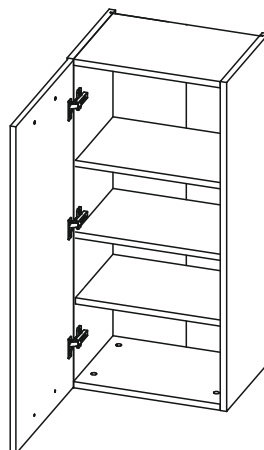
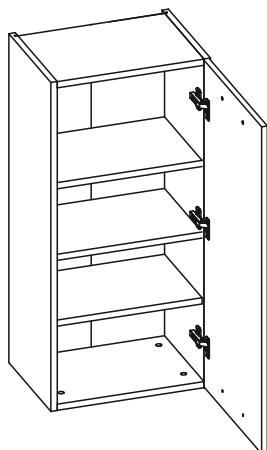

6

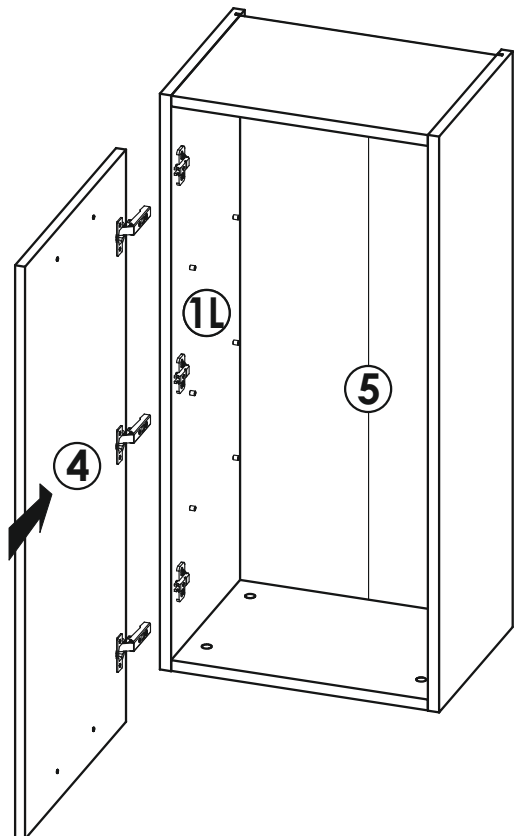
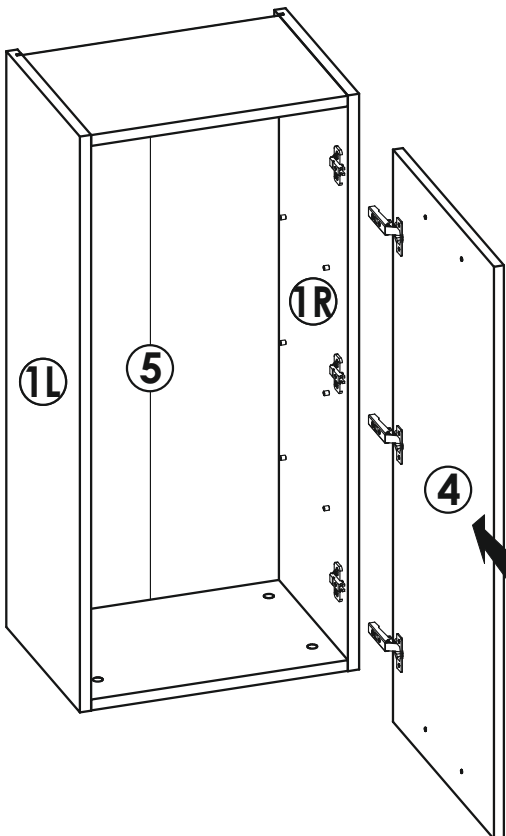
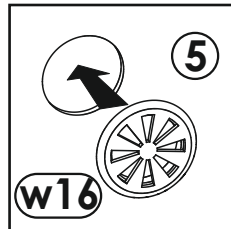
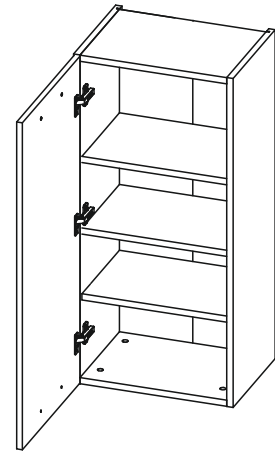
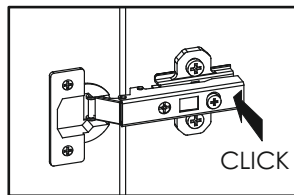
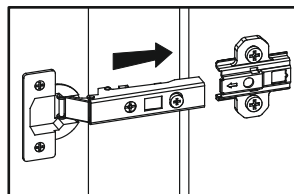
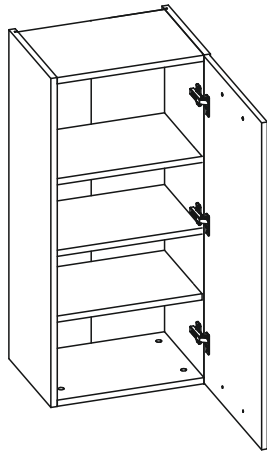
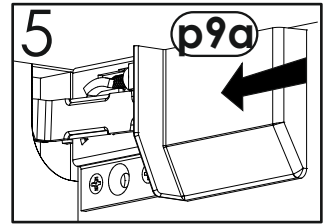
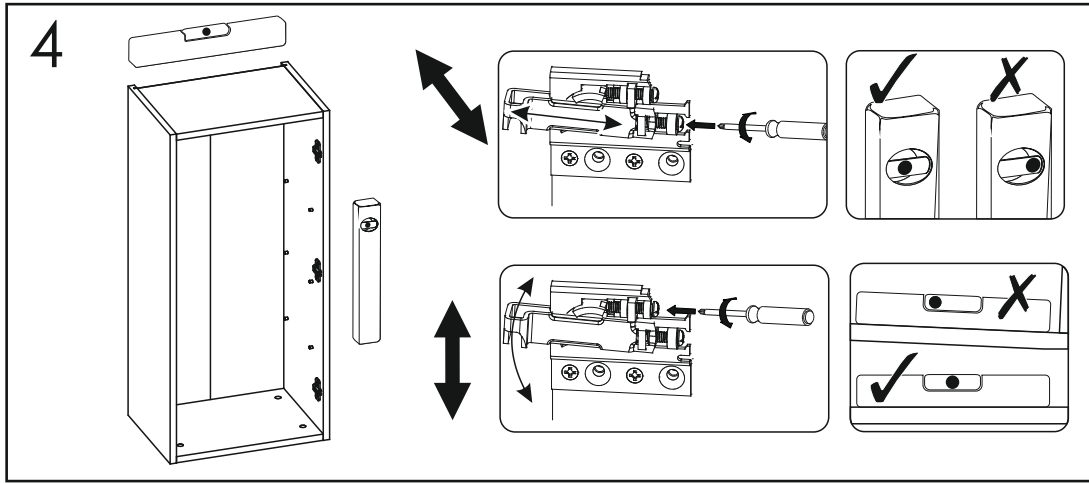
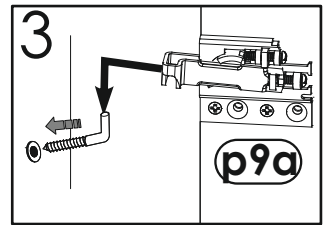
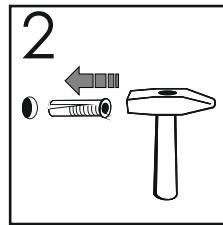
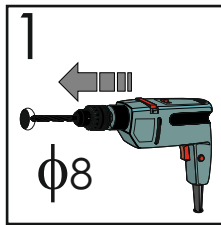

7
▼

